

Data Sheet



Article number: 586350314

Description: Ball Valve 350.314, G 1 1/2" - G 1 1/2"
Thread/Thread

Measures

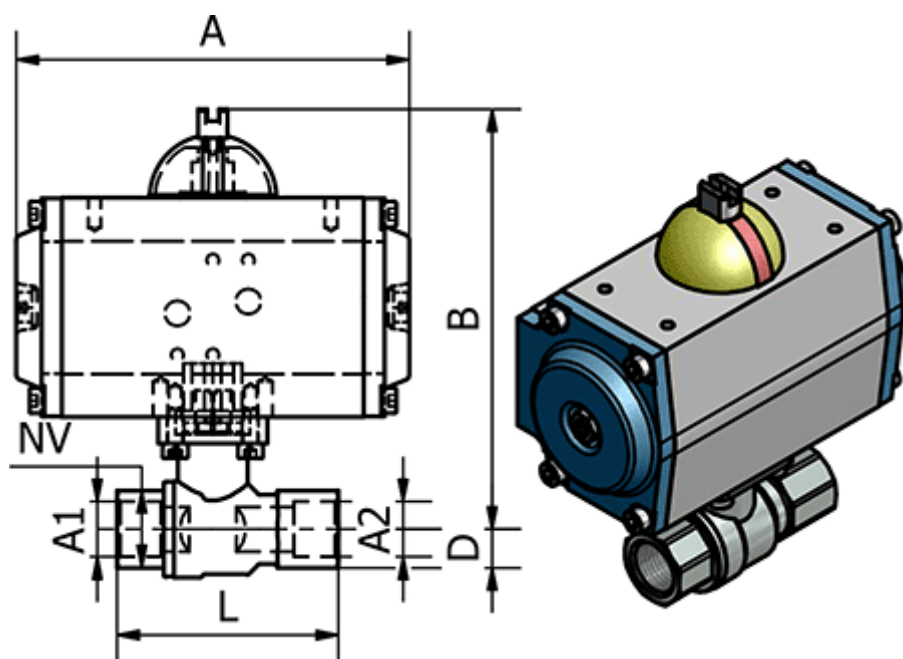

A	= 137
B	= 180
Connecting A1	= G 1 1/2"
Connecting A2	= G 1 1/2"
D	= 36
L	= 120
Max. Operating Pressure	= 25 bar
NV	= 55